

X-ray Inspection System



XR75
A.L.L.
ADVANCED LONG LIFE TECHNOLOGY

Introducing the next generation

XR75

A.L.L.

ADVANCED LONG LIFE TECHNOLOGY



of X-ray inspection technology

Introducing Anritsu's Advanced Long Life Technology



Anritsu's new x-ray technology exceeds the needs of today's demanding food processing industry. In addition to contaminant detection the XR75 inspection system can identify product shape defects and packaging integrity.

Superior image processing allows the Processor to see what they may have been missing in previous x-ray system designs.

The highly engineered high sensitivity x-ray generator and sensor provide outstanding sensitivity at lower energy levels. The result is superior performance, extended life of cycles and reduced true cost of ownership.

The low output x-ray generator reduces heat generation, eliminating the need for cooling system, resulting in a 30% reduction in power consumption.

The Anritsu XR75 x-ray inspection system can reduce the lifetime operating cost by over 20%, as compared to other systems, making x-ray inspection more affordable to purchase, own and operate.

*1) Comparison with conventional models with air-conditioner. *2) It is the estimated value by Anritsu and may vary depending on the condition of machines.

A.L.L. ADVANCED LONG LIFE TECHNOLOGY

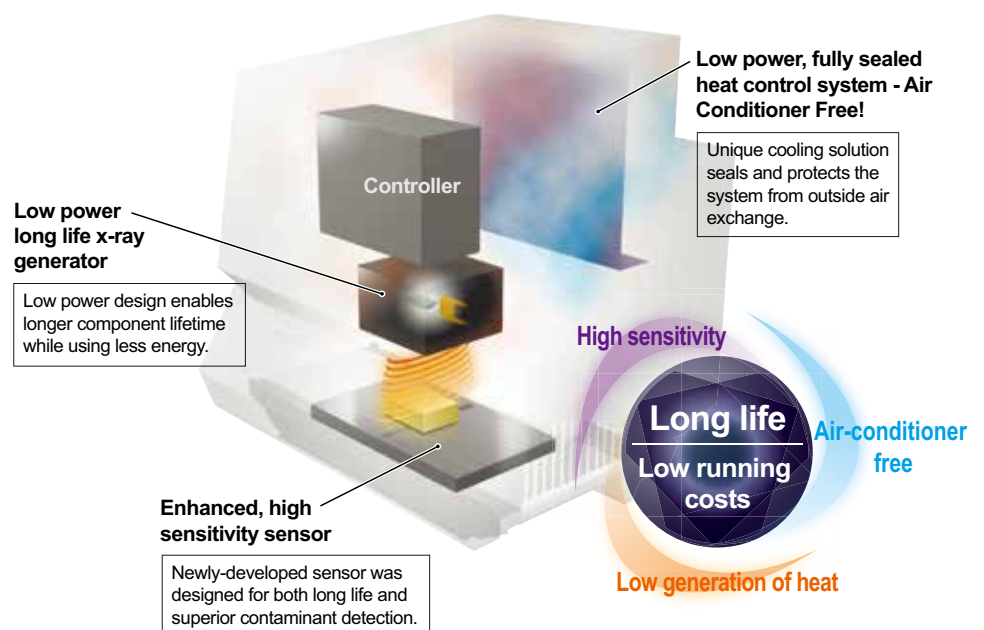

Easy to operate



✔ Simple step-by-step product setup

Product Registration Navigation simplifies parameter setting procedures with step-by-step illustrated instructions.

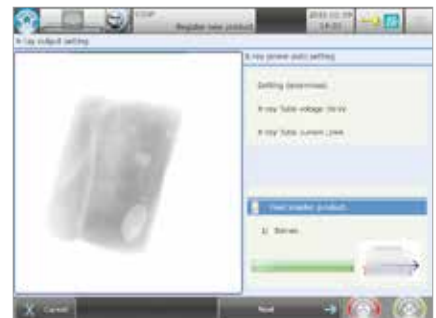

✔ Simple maintenance

[Easy parts removal] No tools are required for removing/attaching the conveyor belts and rollers including the front cover and x-ray leakage prevention curtains.

[Easy-to-clean design] The system's angled surfaces prevent water from accumulating after system cleaning.



Tool free belt removal

✔ Simple information management

X-ray images and inspection logs can be saved to the USB memory for HACCP compliance. All Anritsu systems can be connected, via Ethernet, to QuiCCA. QuiCCA provides line status information, centralized reporting and data storage.



USB interface (USB memory is optional)

Overall quality management and control system - QUICCA



Pasta

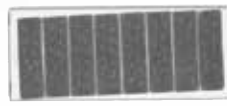

Cookie

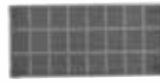

Chocolate

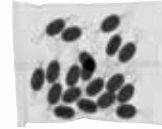

Candy

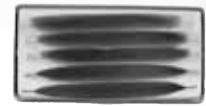

Instant beverage

XR75 delivers industry leading detection for all products.



Asparagus



Syringe



Plastic cup



Tube



Sliced meat



Sausage



Prawn

✔ HD imaging provides the best-in-industry detection.

Signal processing that picks up only signals for contaminants accurately and image analysis algorithm have been developed numerously by our unique technology. Contaminants such as bone fragments and resins are detected at high sensitivity by using the appropriate algorithm according to physical properties of products and property of packages.

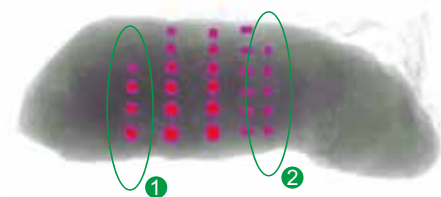

X-ray image of test pieces in 500g tenderloin. Accurate detection of small Nylon ① and SUS ② spheres is now possible.

Point
[Easy to adjust sensitivity]
 An x-ray processed image and a projection monitor on which detection signals are shown graphically are spotted vertically on the screen. The detection limit value can be easily adjusted.

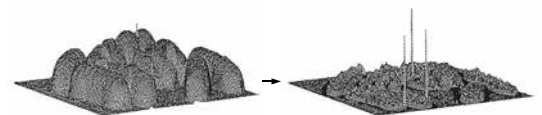

Signal processing advancements allow detection of smaller contaminants.

✔ Go Beyond Contaminant Detection

XR75 provides not only contaminant detection but also product verification simultaneously. Products can be inspected for missing product, virtual weight, count, package check, void check, etc.

[Shape Detection] The shape, area and mass are analyzed from x-ray images to find irregularities including breaks and chips. Missing fillings can also be spotted.

[Missing Product Detection] Inspection for missing products are available for those products in which the content is indicated by the number, and the mass of each piece in a package varies per piece.



Chipped biscuit

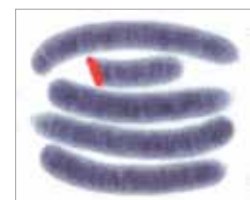

Cut sausage

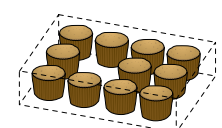
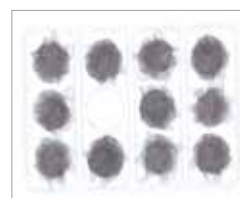

[Example of a package containing 12 cupcakes with 20 ±2 g each] The weight of 11 pieces with 22 g each totals 242 g, which satisfies weight requirement but the count is short.

Safety in design

XR75 **ALL**
ADVANCED X-RAY TECHNOLOGY

Anritsu believes customer safety is of utmost importance.

Anritsu safety mechanism

Emergency stop switch

Cuts power to x-ray and drive circuits, stops the conveyor and x-ray radiation.

X-ray ON/OFF key

Turning the key to OFF stops x-ray radiation completely.

X-ray shield cover open/close sensor

Opening the cover stops x-ray radiation.

X-ray shield cover

Opened/Closed using x-ray Irradiation ON/OFF Key.

Opening the cover stops x-ray radiation due to the x-ray Shield Cover Open/Close Sensor.

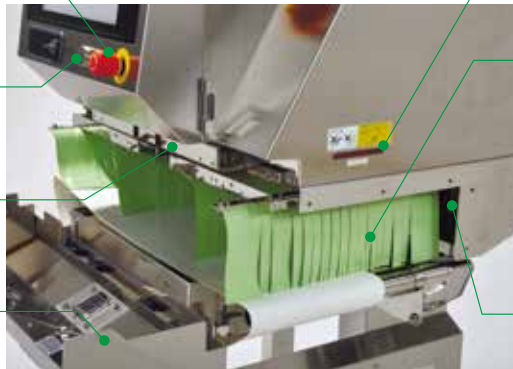

X-ray irradiation display

The lamp is lit during x-ray radiation.

Leakage prevention curtain

Prevents x-ray leakage. For unpackaged or bulk products, the standard lead impregnated curtains are replaced with SUS covers - preventing direct food contact with the curtains.

Hand insertion sensor

Interrupting the sensor for a certain period of time stops x-ray radiation.

Safety management

X-ray inspection system has been designed to fully satisfy the safe operation. However, to ensure even higher safety, use the safety procedures outlined below.

① Periodic measurement and recording of x-ray leakage data

② Management of operator working hours

③ Additional safety measures

Covers may need to be mounted on upstream and downstream conveyors instead of the shield curtains, depending on the shape, weight, and package of products.

④ No disassembly or modification

NEVER modify or disassemble the main unit, covers, x-ray leakage prevention curtains, safety covers, safety interlocks, etc., otherwise the x-ray leak-proof design may no longer be functional.

Safety of inspected products

WHO concluded in 1980 that the "irradiation of any food commodity up to an overall average dose of 10 kGy presents no toxicological hazard and introduces no special nutritional or microbiological problems."

The maximum dose of x-ray irradiation to the products to be inspected by our x-ray inspection systems is 0.002 Gy, which is much lower than the value described above. Even if a product stops inside, the x-ray dose is always kept to 0.1 Gy or less.

Note: Follow the local laws and regulations regarding the installation and use of the x-ray inspection systems.

Major specifications

XR75 

For Packaged Products

External Dimensions



KXS7522AWCLE
KXS7522AVCLE

KXS7534AWCLE
KXS7534AVCLE

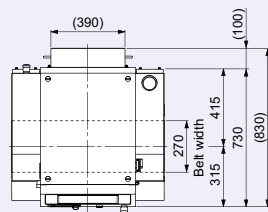

Detection area

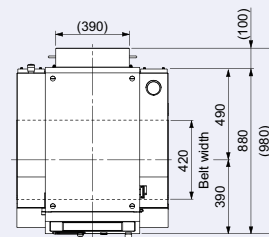
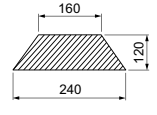

Detection area

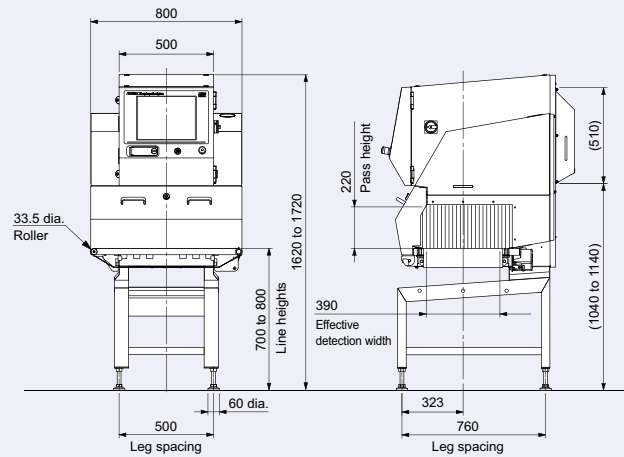
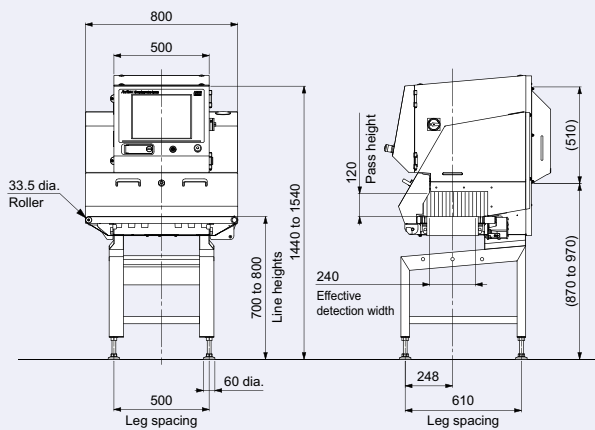
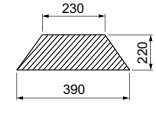

Dimensions in brackets are waterproof on the entire surface. Units: mm

Specifications



| Model | KXS7522AWCLE | KXS7522AVCLE | KXS7534AWCLE | KXS7534AVCLE |
|--|---|---------------------------------|---|---------------------------------|
| X-ray output | Tube voltage 30 to 80 kV, tube current 0.4 to 3.3 mA, output 12 to 100 W | | | |
| Safety | X-ray leakage maximum 1.0 μ Sv/h or less, prevention of x-ray leakage by safety devices | | | |
| Display | 15-inch color TFT LCD | | | |
| Operation method | Touch panel (with touch buzzer) | | | |
| Detection area ^{1,2} | Maximum width 240 mm, maximum height 120 mm | | Maximum width 390 mm, maximum height 220 mm | |
| Belt width | 270 mm | | 420 mm | |
| Preset memory | 200 | | | |
| Belt speed ³ / Maximum product weight ⁴ | 10 to 60 m/min, maximum 5 kg | | 10 to 60 m/min, maximum 5 kg | |
| | 60 to 90 m/min, maximum 2 kg | | — | |
| | 10 to 40 m/min, maximum 10 kg (optional) | | 10 to 40 m/min, maximum 10 kg (optional) | |
| Power requirements ⁵ | 100 Vac to 240 Vac, single phase, 50/60 Hz, 700 VA or less (standard) | | | |
| Mass ⁶ | 245 kg | 250 kg | 305 kg | 310 kg |
| Environmental conditions ^{7,8} | Temperature: 0°C to 35°C, Relative humidity: 30% to 85%, non-condensing | | | |
| Protection class | Conveyor: IP66 Other parts: IP40 | Entire surface conforms to IP66 | Conveyor: IP66 Other parts: IP40 | Entire surface conforms to IP66 |
| Exterior | Stainless steel (SUS304) | | | |

1 : The product size should fall below the detection area.

2 : The entrance and exit may require covers depending on the length of a product.

3 : Variable depending on Product No.

4 : Sum total of product weight on the conveyor.

5 : Allowable power fluctuation range is \pm 10%.

6 : Mass without option.

7 : For KXS7522AWCLE and KXS7522AVCLE, belt speed and maximum product weight are restricted at the temperature between 30°C and 35°C.

8 : The temperature between 0°C and 40°C when an optional air conditioner is installed. (AWCLE only)

Major specifications

XR75 

**For Lightweight Products
and Those in Small Bags**

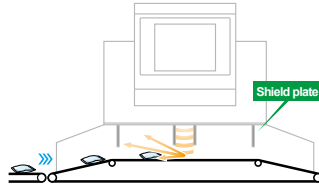

External Dimensions

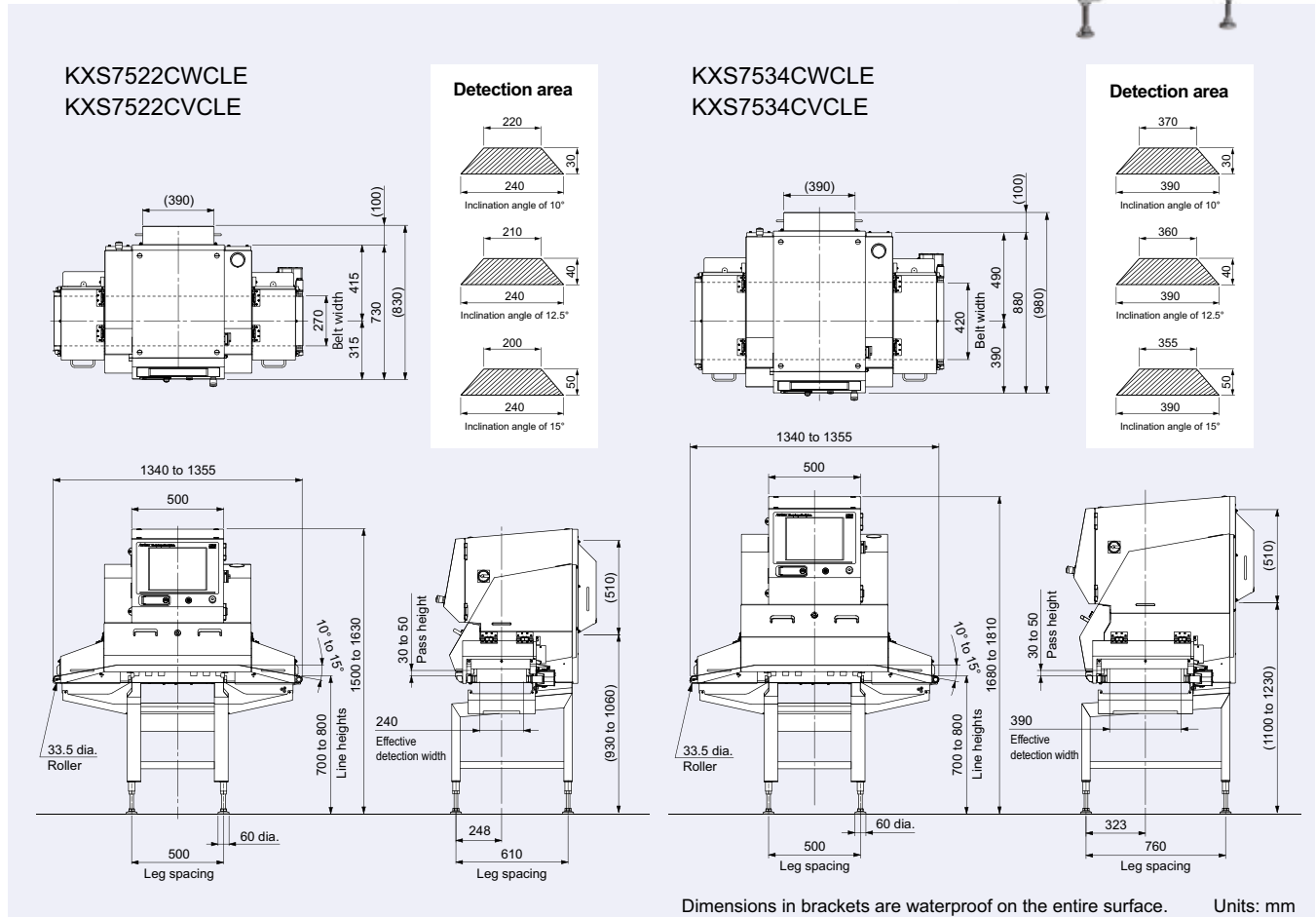

Specifications



| Model | KXS7522CWCLE | KXS7522CVCLE | KXS7534CWCLE | KXS7534CVCLE |
|--|--|------------------------------------|--|------------------------------------|
| X-ray output | Tube voltage 25 to 60 kV, tube current 0.4 to 3.3 mA, output 10 to 100 W | | | |
| Safety | X-ray leakage maximum 1.0 μSv/h or less, prevention of x-ray leakage by safety devices | | | |
| Display | 15-inch color TFT LCD | | | |
| Operation method | Touch panel (with touch buzzer) | | | |
| Detection area ^{1,2} | Maximum width 240 mm, maximum height 50 mm | | Maximum width 390 mm, maximum height 50 mm | |
| Belt width | 270 mm | | 420 mm | |
| Preset memory | 200 | | | |
| Belt speed ³ / Maximum product weight ⁴ | 10 to 50 m/min, maximum 5 kg | | | |
| Power requirements ⁵ | 100 Vac to 240 Vac, single phase, 50/60 Hz, 700 VA or less (standard) | | | |
| Mass ⁶ | 270 kg | 275 kg | 340 kg | 345 kg |
| Environmental conditions ^{7,8} | Temperature: 0°C to 35°C, Relative humidity: 30% to 85%, non-condensing | | | |
| Protection class | Conveyor: IP66 Other parts: IP40 | Entire surface conforms to IP66 | Conveyor: IP66 Other parts: IP40 | Entire surface conforms to IP66 |
| Exterior | Stainless steel (SUS304) | | | |

1 : The product size should fall below the detection area.

2 : The entrance and exit may require covers depending on the length of a product.

3 : Variable depending on Product No.

4 : Sum total of product weight on the conveyor.

5 : Allowable power fluctuation range is ±10%.

6 : Mass without option.

7 : For KXS7522CWCLE and KXS7522CVCLE, belt speed and maximum product weight are restricted at the temperature between 30°C and 35°C.

8 : The temperature between 0°C and 40°C when an optional air conditioner is installed. (CWCLE only)

Major specifications

XR75 **ALL**
ADVANCED X-RAY TECHNOLOGY

For Bulk Flow of Unpacked Fresh Food

Applicable models: KXS7522AWCLE, KXS7522AVCLE,
 KXS7534AWCLE, KXS7534AVCLE



This option is for those unpackaged products that require the inspection without the leakage prevention curtain.

- Flow direction can be changed from left to right and vice versa.
- A separate modification is required for the change of flow direction after the installation.

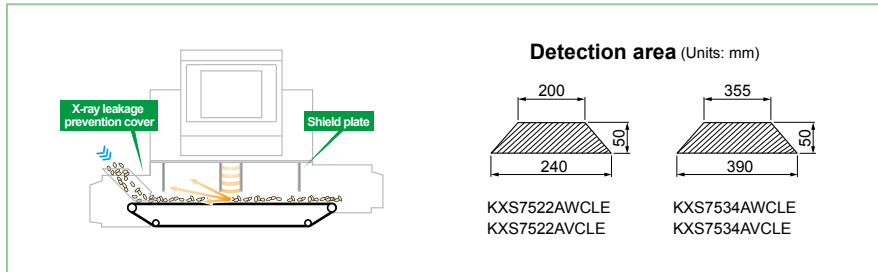

* Contact our sales representatives for details.

| Model | Detection area (Units : mm) | Page |
|------------------------------|--|------|
| KXS7522AWCLE KXS7522AVCLE | $\text{Effective detection width} = 240 - \frac{80 \times H_p}{120}$ $\text{Effective detection height} = \frac{120 \times (240 - W_p)}{80}$ | 7 |
| KXS7522CWCLE KXS7522CVCLE | $\text{Effective detection width} = 240 - \frac{40 \times H_p}{50}$ $\text{Effective detection height} = \frac{50 \times (240 - W_p)}{40}$ | 8 |
| KXS7534AWCLE KXS7534AVCLE | $\text{Effective detection width} = 390 - \frac{160 \times H_p}{220}$ $\text{Effective detection height} = \frac{220 \times (390 - W_p)}{160}$ | 7 |
| KXS7534CWCLE KXS7534CVCLE | $\text{Effective detection width} = 390 - \frac{35 \times H_p}{50}$ $\text{Effective detection height} = \frac{50 \times (390 - W_p)}{35}$ | 8 |

Note: Any one of the pass heights can be selected.



ANRITSU INFIVIS CO., LTD.

International Sales Department

5-1-1 Onna, Atsugi-shi, Kanagawa-Prf., 243-0032, JAPAN
TEL: +81-46-296-6699 FAX: +81-46-296-6786
<https://www.anritsu.com/infivis>

Anritsu Industrial Solutions (Shanghai) Co., Ltd.

3F, No.55, Lane 1505, Zuchongzhi Road, Zhangjiang Hi-tech Park, Pudong New Area, Shanghai 201203, P.R.China
TEL: +86-21-5046-3066 FAX: +86-21-5046-3068

ANRITSU INFIVIS (THAILAND) CO., LTD.

700/678 Moo 1, Amata Nakorn Industrial Estate, T. Pangthong A. Pangthong Chonburi Province Thailand 20160
TEL: +66 38-447180 FAX: +66 38-447182

ANRITSU INFIVIS LTD.

Unit 3, Scott Road, Luton, LU3 3BF, United Kingdom
TEL: +44 (0)845 539 9729

ANRITSU INFIVIS INC.

1001 Cambridge Drive. Elk Grove Village, IL 60007-2453, U.S.A.
TEL: +1-847-419-9729 FAX: +1-847-537-8266

© ANRITSU INFIVIS CO., LTD. 2015

ISO14001 CERTIFICATE No.JQA-EM0210
ISO 9001 CERTIFICATE No.JQA-0316

- Some products shown in this catalog may not be available in your country or region. Contact our sales representatives for details.
- To ensure proper operation, read the Operation Manual before using the machine.
- In addition to daily inspection, a full maintenance inspection should be completed annually.

Specifications are subject to change without notice.
No part of this catalog may be reproduced without our permission.